

# Bali® Measuring Guide for Roman Shades

## Tools and Tips

- Steel tape measure — do not use cloth tape
- Pencil
- Bali Measurement Worksheet – visit [baliblinds.com](http://baliblinds.com)
- How to Measure Videos – visit [baliblinds.com](http://baliblinds.com)
- Measure each window and identify window locations – size variances are common
- Round measurements to the nearest 1/8"
- Clearly record measurements – width vs. height

1/8"  
1/4"  
3/8"  
1/2"  
5/8"  
3/4"  
7/8"

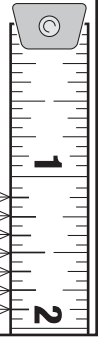

## Choose a Mount Type: Inside Mount or Outside Mount

(See next page if you need help deciding which mount is best for your windows.)

### Inside Mount

Window treatments are installed completely inside the window casing.

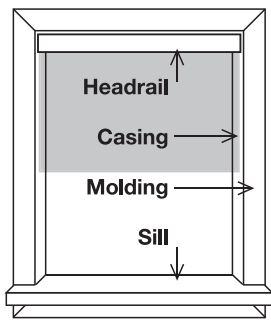

Inside Mount Blind

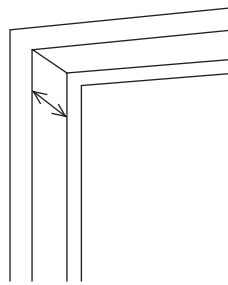

Depth

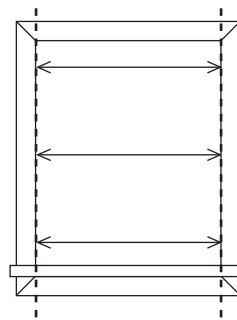

Width

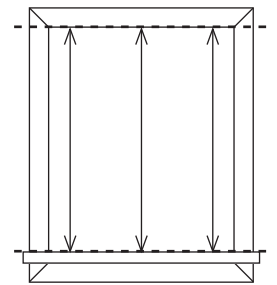

Height

- ➊ **Measure Depth:** See the chart on next page to determine if window casing has enough depth for an inside-mount window treatment.
  - ➋ **Measure Width:** Measure the inside width of window casing in three places. Record narrowest measurement.
  - ➌ **Measure Height:** Measure the inside height from the top of window casing to top of sill in three places. Record longest measurement.
- Note:** Do not take any deductions for clearance. The manufacturer will take necessary deductions for a perfect fit.

### Outside Mount

Window treatments are installed outside the window casing. Mount directly to wall or molding.

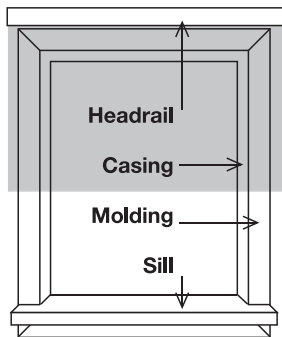

Outside Mount Blind

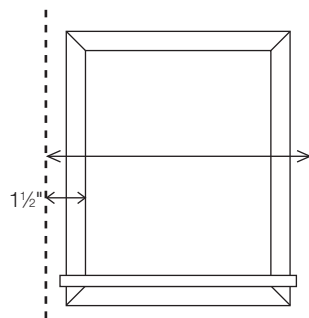

Width

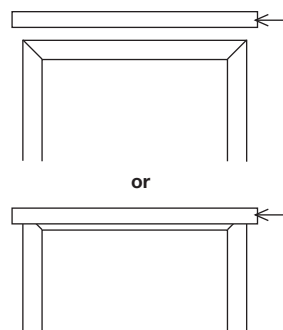

Headrail Location

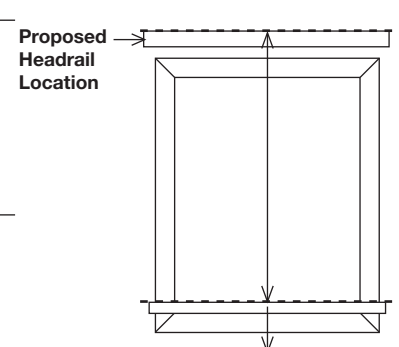

Height

- ➊ **Measure Width:** Measure width to be covered. We recommend 1 1/2" overlap on each side (3" total) for optimum light control and privacy. Record measurement.
- ➋ **Determine Headrail Location** Determine if headrail will be on molding or above molding and mark spot.
- ➌ **Measure Height:** Measure height to be covered from top of headrail location to top of sill or lower if overlap is desired for light control and privacy. Record measurement.

**Note:** The manufacturer makes NO deductions on outside-mount installations.

# Mounting Considerations

## Reason for Choosing Inside Mount

### Clean Look

- Inside-mount treatments are installed inside the window casing, showcasing attractive window trim.
- The window opening frames the treatment for a finished, clean appearance.

### Allows Sill Space on Deep Windows

- In some deep-set windows, the window treatment can be installed to allow plants or other items to be placed in front of the window treatment on the sill.

## Limitations of Inside Mount

### Light Gaps

- A small deduction in the width is taken at the manufacturer to allow for proper operating clearance, and this causes a small gap on each side of the treatment, affecting the treatment's ability to darken and insulate a room.

### Obstructed View

- The stack (compressed portion of the window treatment when fully raised) will obstruct a part of the view from the window.
- The amount of stack varies by product.

### Architectural Obstacles

- Obstacles such as handles and cranks can interfere with the operation of inside-mount treatments.

## Reason for Choosing Outside Mount

### Improve Privacy and Light Control

- Light gaps on the side of the window treatment can be substantially diminished or eliminated.

### Fewer Installation Limitations

- Outside-mount window treatments are ideal for covering non-square windows.
- Outside-mount window treatments are installed higher than the window opening, preventing the stack from obstructing light or view when fully raised.

### Architectural Obstacles

- Outside-mount window treatments can clear obstacles like handles and cranks.

### Enlarge the Look of a Small Window

- Enlarge the look of a small window by increasing overlap above and below the window.

### Hide Window Trim

- Outside-mount treatments provide an easy way to hide unattractive window trim.

## Limitations of Outside Mount

### Required Surface Above Window Frame

- Outside-mount brackets require at least 2" of flat surface above your window or on the window frame for mounting brackets; Projection brackets or shims can be ordered to clear frame or molding.

## Inside Mount Window Casing Minimum Depth Requirements

**A. Flush Mount:** If the window casing is deep enough to mount the entire headrail and fabric inside of it, this is called a flush mount.

**B. Partially Recessed:** A partially recessed window treatment is when the depth of the window casing is less than the space necessary for a flush mount.

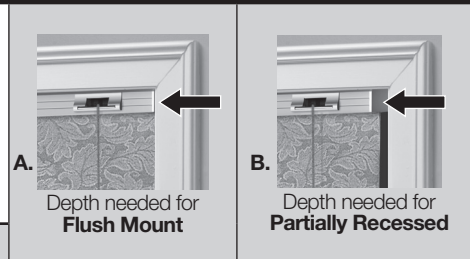

| Roman Shades    | Control Type         | Fabric Style    | Depth needed for Flush Mount | Depth needed for Partially Recessed |
|-----------------|----------------------|-----------------|------------------------------|-------------------------------------|
| Custom Tailored | Standard Cord Lift   | Looped          | 3½"                          | ¾"                                  |
|                 |                      | Flat & Seamless | 2¼"                          |                                     |
|                 | Continuous-loop Lift | Looped          | 4¼"                          |                                     |
|                 |                      | Flat & Seamless | 3"                           |                                     |
|                 | Bottom Up/Top Down   | Looped          | 3½"                          |                                     |
|                 |                      | Flat & Seamless | 2¼"                          |                                     |
| Casual Classics | Standard Cord Lift   | Looped          | 3½"                          | ¾"                                  |
|                 |                      | Flat            | 1⅞"                          |                                     |
|                 | Continuous-loop Lift | Looped          | 3½"                          |                                     |
|                 |                      | Flat            | 2⅞"                          |                                     |
|                 | Bottom Up/Top Down   | Looped          | 3½"                          |                                     |
|                 |                      | Flat            | 1⅞"                          |                                     |
|                 | Cordless/Motorized   | Looped          | 3½"                          |                                     |
|                 |                      | Flat            | 2⅞"                          |                                     |

Flush mount includes headrail and fabric and is approximate. This can vary by fabric. Please call 1-877-792-0002 for window casing depth requirements of specialty Roman Shades not listed in the above chart.

# Measuring and Ordering Worksheet

**Window #1** \_\_\_\_\_

(location)

## Measuring

### For Inside Mount

Depth of window casing: \_\_\_\_\_

Measure width of window in 3 places and circle the narrowest width below:

Width #1: \_\_\_\_\_

Width #2: \_\_\_\_\_

Width #3: \_\_\_\_\_

Measure height of window in 3 places and circle the longest height below:

Height #1: \_\_\_\_\_

Height #2: \_\_\_\_\_

Height #3: \_\_\_\_\_

### For Outside Mount

Width: \_\_\_\_\_

Height: \_\_\_\_\_

## Ordering

Mount Type:  Inside  Outside

Ordering Width: \_\_\_\_\_

Ordering Height: \_\_\_\_\_

Type of Blind or Shade: \_\_\_\_\_

Style Name: \_\_\_\_\_

Color Number: \_\_\_\_\_

Controls & Options to consider:

Corded

Cordless

Bottom Up/Top Down  
(Cellular, Pleated, Roman, and Natural Shades)

Sun Up/Sun Down  
(Cellular & Pleated Shades only)

Cornice: \_\_\_\_\_

Valance: \_\_\_\_\_

Other: \_\_\_\_\_

**Window #2** \_\_\_\_\_

(location)

## Measuring

### For Inside Mount

Depth of window casing: \_\_\_\_\_

Measure width of window in 3 places and circle the narrowest width below:

Width #1: \_\_\_\_\_

Width #2: \_\_\_\_\_

Width #3: \_\_\_\_\_

Measure height of window in 3 places and circle the longest height below:

Height #1: \_\_\_\_\_

Height #2: \_\_\_\_\_

Height #3: \_\_\_\_\_

### For Outside Mount

Width: \_\_\_\_\_

Height: \_\_\_\_\_

## Ordering

Mount Type:  Inside  Outside

Ordering Width: \_\_\_\_\_

Ordering Height: \_\_\_\_\_

Type of Blind or Shade: \_\_\_\_\_

Style Name: \_\_\_\_\_

Color Number: \_\_\_\_\_

Controls & Options to consider:

Corded

Cordless

Bottom Up/Top Down  
(Cellular, Pleated, Roman, and Natural Shades)

Sun Up/Sun Down  
(Cellular & Pleated Shades only)

Cornice: \_\_\_\_\_

Valance: \_\_\_\_\_

Other: \_\_\_\_\_

**Window #3** \_\_\_\_\_

(location)

## Measuring

### For Inside Mount

Depth of window casing: \_\_\_\_\_

Measure width of window in 3 places and circle the narrowest width below:

Width #1: \_\_\_\_\_

Width #2: \_\_\_\_\_

Width #3: \_\_\_\_\_

Measure height of window in 3 places and circle the longest height below:

Height #1: \_\_\_\_\_

Height #2: \_\_\_\_\_

Height #3: \_\_\_\_\_

### For Outside Mount

Width: \_\_\_\_\_

Height: \_\_\_\_\_

## Ordering

Mount Type:  Inside  Outside

Ordering Width: \_\_\_\_\_

Ordering Height: \_\_\_\_\_

Type of Blind or Shade: \_\_\_\_\_

Style Name: \_\_\_\_\_

Color Number: \_\_\_\_\_

Controls & Options to consider:

Corded

Cordless

Bottom Up/Top Down  
(Cellular, Pleated, Roman, and Natural Shades)

Sun Up/Sun Down  
(Cellular & Pleated Shades only)

Cornice: \_\_\_\_\_

Valance: \_\_\_\_\_

Other: \_\_\_\_\_

For next steps and where to buy visit:

**baliblinds.com**